

TG9 Series

TA224 .05

4M Size Plate with 4 holes + 2M window Aluminium Black

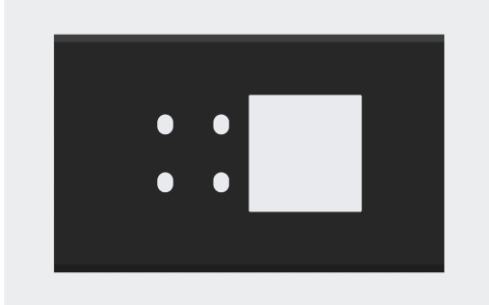

Code:	TA224 .05
Series:	TG9 Series
Family:	Solid Aluminium Plates
Module Size:	Four Module
Colour:	Aluminium Black
Mark:	Norisys
Rated supply voltage:	----
Maximum resistive load:	----
Dimensions:	95.1mm x 92.3mm x 14.1mm
Weight:	191.5g

Wiring Diagram:

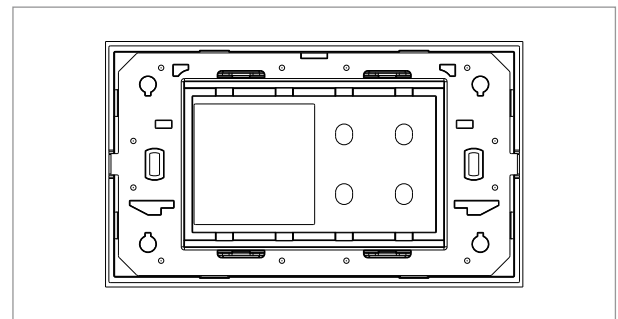

Drawings:

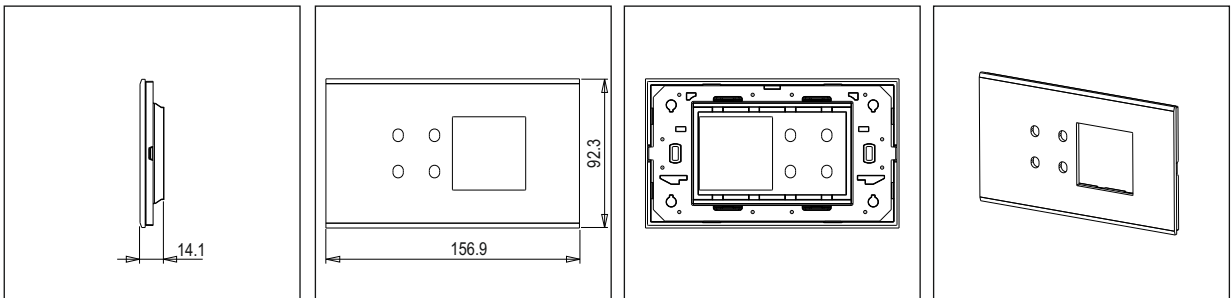

Installation:

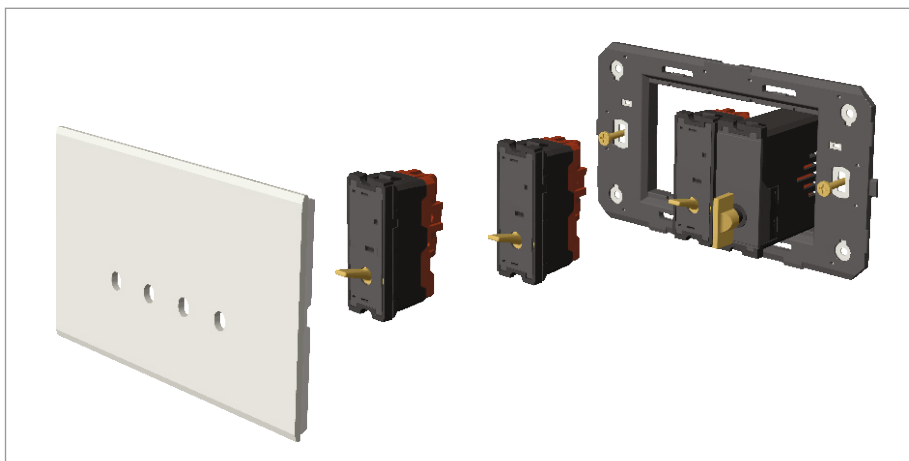

Installation of the product should be carried out in compliance with the current regulations regarding the installation of electrical systems in the country where the product is installed.

The product should be installed by a trained professional following all safety norms.

Keep away from water and wet surfaces. While mounting the product, hands should not be wet.