

**SQUARE Series**

**S7904 .01**

Fan Regulators Single Module for 80W Fan - Step Type - 1 module Frost White

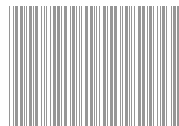

5267.51.8



Code:	S7904 .01
Series:	SQUARE Series
Family:	Fan Regulator & Dimmer
Module Size:	One Module
Colour:	Frost White
Mark:	Norisys
Rated supply voltage:	240V
Maximum resistive load:	80W
Dimensions:	24mm x 67.4mm x 60.23mm
Weight:	43.8g

Wiring Diagram:

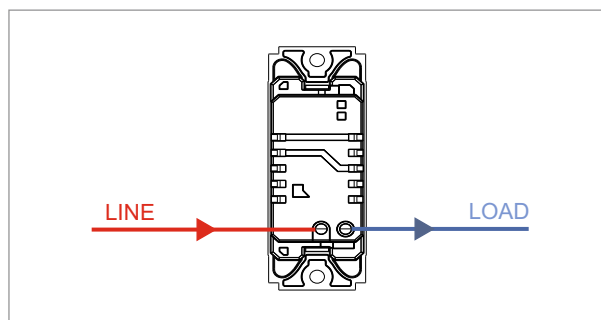

Drawings:

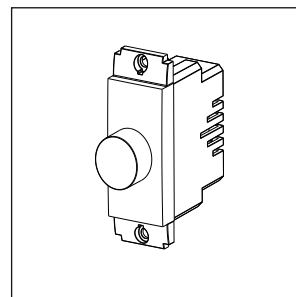
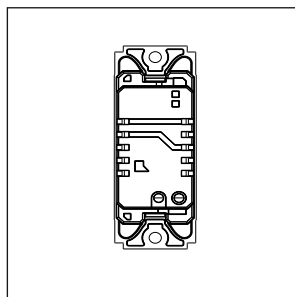
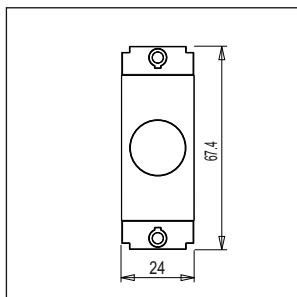
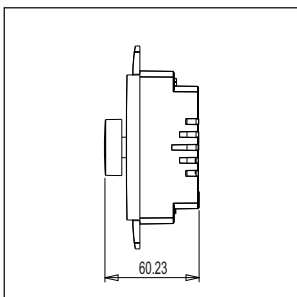

Installation:

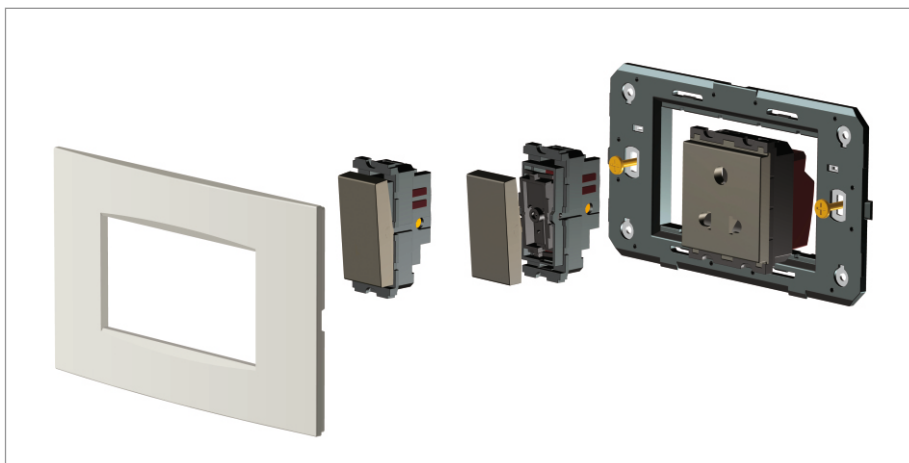

Installation of the product should be carried out in compliance with the current regulations regarding the installation of electrical systems in the country where the product is installed.

The product should be installed by a trained professional following all safety norms.

Keep away from water and wet surfaces. While mounting the product, hands should not be wet.