

CUBE Series

C5911 .17

Fan Regulator for 120W fan - Step Type with Round Knob - 2 module Charcoal Black

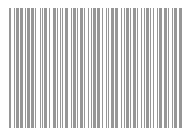
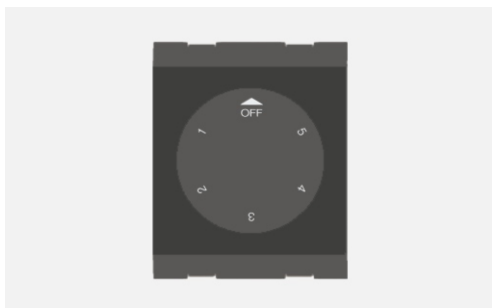

5267.51.8



Code:	C5911 .17
Series:	CUBE Series
Family:	Fan Regulator & Dimmers
Module Size:	Two Module
Colour:	Charcoal Black
Mark:	Norisys
Rated supply voltage:	240V
Maximum resistive load:	120W
Dimensions:	55.6mm x 44.9mm x 62.3mm
Weight:	73.80g

Wiring Diagram:

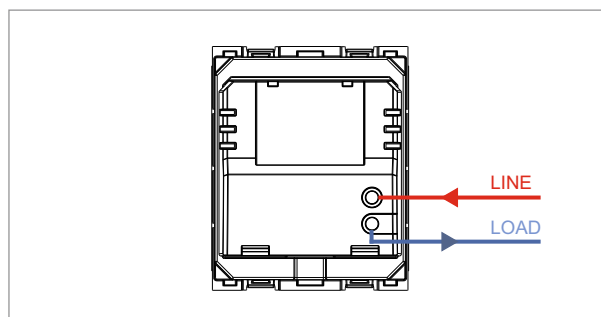

Drawings:

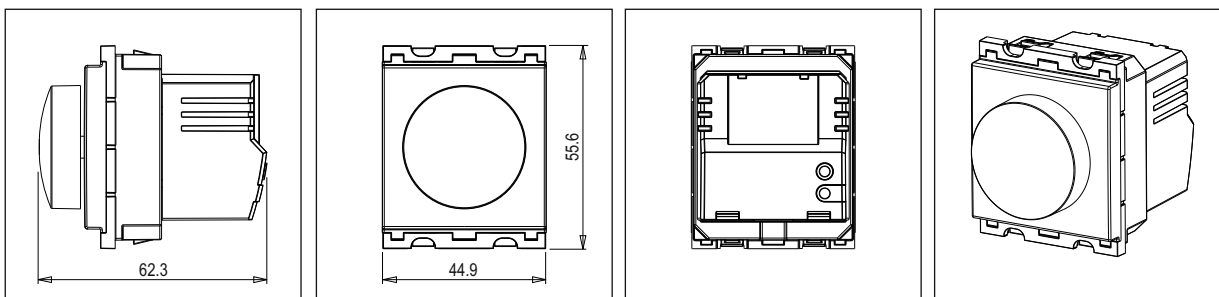

Installation:

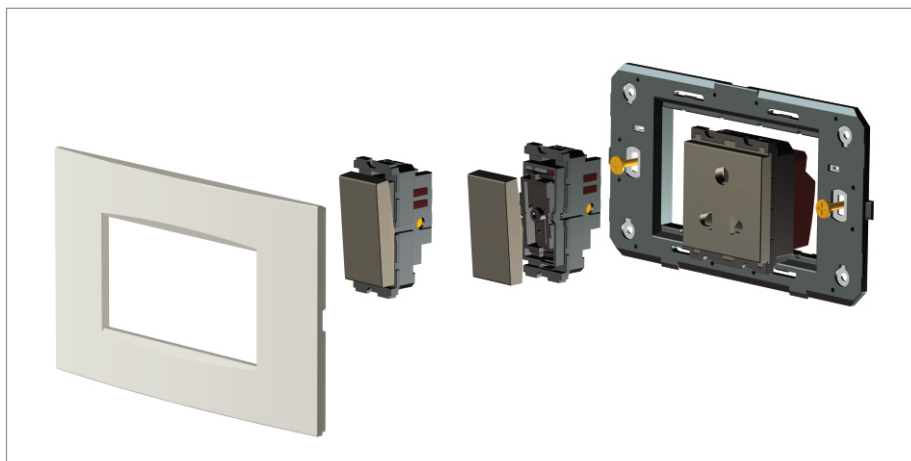

Installation of the product should be carried out in compliance with the current regulations regarding the installation of electrical systems in the country where the product is installed.

The product should be installed by a trained professional following all safety norms.

Keep away from water and wet surfaces. While mounting the product, hands should not be wet.