

CUBE Series

C5732 .20

Socket 25A and 6A - 3 Pin Shuttered - 2 module Scarlet Red

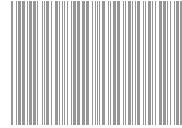
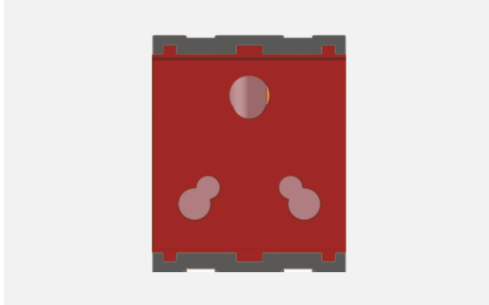

5267.51.8



Code:	C5732 .20
Series:	CUBE Series
Family:	Socket
Module Size:	Two Module
Colour:	Scarlet Red
Mark:	Norisys
Rated supply voltage:	240V
Maximum resistive load:	25A & 6A
Dimensions:	55.6mm x 44.9mm x 40.1mm
Weight:	68.50 g

Wiring Diagram:

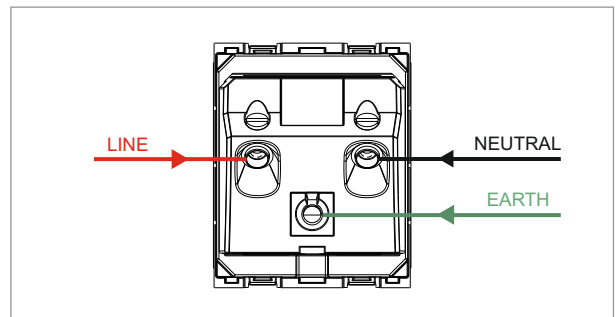

Drawings:

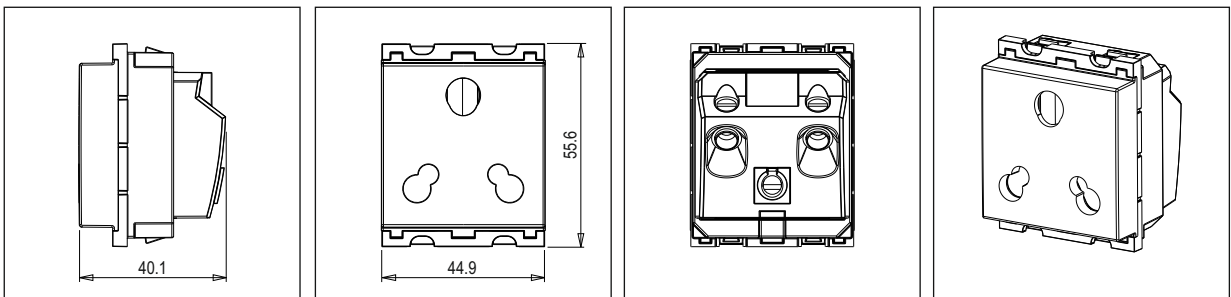

Installation:



Installation of the product should be carried out in compliance with the current regulations regarding the installation of electrical systems in the country where the product is installed.

The product should be installed by a trained professional following all safety norms.

Keep away from water and wet surfaces. While mounting the product, hands should not be wet.